

INSTRUCTIONS FOR USE

Abridged version



Ambu

Ambu® Gastroscope

For use by trained healthcare professionals.
For use in professional healthcare facilities.
For use with Ambu® aBox™ 2

aScope™ Gastro
aScope™ Gastro Large

QUICK GUIDE

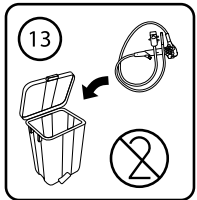
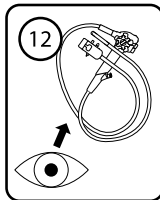
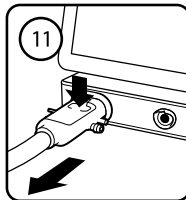
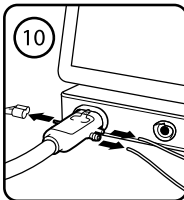
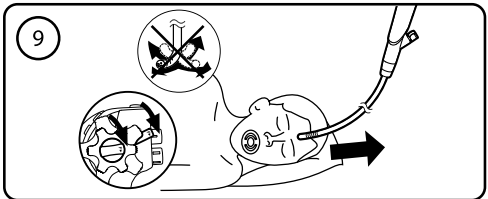
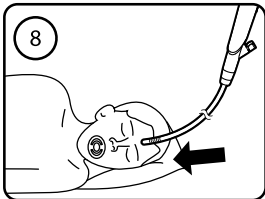
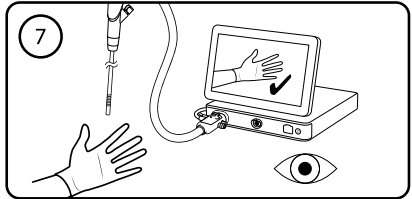
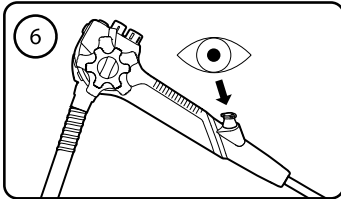
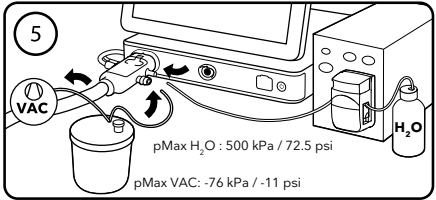
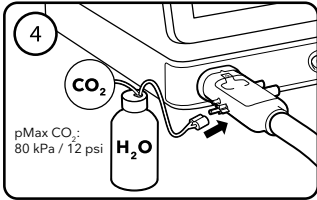
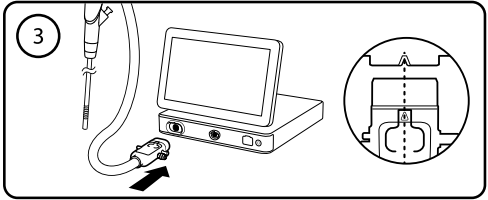
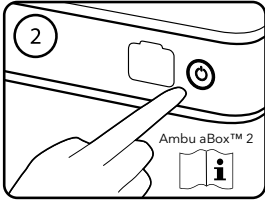
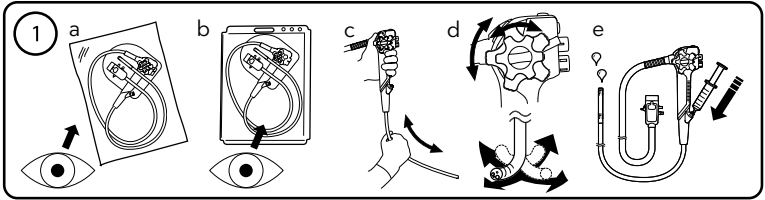

CONTENTS

PAGE

English (Instructions for use)4-19

1. Important information – Read before use

Read the Instructions for Use (IFU) carefully before using the Ambu® aScope™ Gastro or Ambu® aScope™ Gastro Large. These instructions describe the function, setup and precautions related to operating the Ambu® aScope™ Gastro or Ambu® aScope™ Gastro Large. Please be aware that these instructions do not describe clinical procedures. Prior to use of the Ambu® aScope™ Gastro or Ambu® aScope™ Gastro Large, it is important for operators to have received sufficient training in clinical endoscopic techniques and to be familiar with the intended use, warnings, cautions, indications and contraindications mentioned in these instructions. There is no warranty for the Ambu® aScope™ Gastro or Ambu® aScope™ Gastro Large. In this document Ambu® aScope™ Gastro and Ambu® aScope™ Gastro Large refer to instructions which apply to the endoscopes only, while system often refers to information relevant for the Ambu® aScope™ Gastro or Ambu® aScope™ Gastro Large in combination with the compatible Ambu® aBox™ 2 displaying unit and accessories. The IFU may be updated without further notice. Copies of the current version are available upon request.

In this document, the term endoscope refers to the Ambu® aScope™ Gastro and Ambu® aScope™ Gastro Large and displaying unit refers to Ambu® aBox™ 2.

1.1. Intended use

The endoscope is a sterile, single-use, flexible gastroscope intended to be used for endoscopic access to and examination of the upper gastrointestinal anatomy. The endoscope is intended to provide visualization via a compatible Ambu displaying unit and to be used with endotherapy accessories and other ancillary equipment.

1.2. Intended patient population

The endoscope is intended to be used in adults; this means patients with the age of 18 years or above. The endoscope is used in patients with indications in the upper gastrointestinal anatomy requiring visualization and/or examination with flexible gastroscopy and use of endotherapy accessories and/or equipment.

1.3. Contraindications

No known contraindications.

1.4. Clinical benefits

The endoscope, when used with the compatible displaying unit, enables visualization, examination, and endoscopic intervention of key anatomical structures in the upper gastrointestinal (GI) tract, particularly esophagus, gastroesophageal junction, stomach, pylorus, duodenal bulb, and descending duodenum. High-definition imaging technology will enable endoscopists to view mucosal and vascular structures. The risk of endoscope-related patient cross-contamination is eliminated compared to reusable endoscopes, as the endoscope is a sterile single-use medical device.

1.5. Warnings and cautions

WARNINGS

1. For single use only. Do not reuse, reprocess or resterilize as these processes may leave harmful residues or cause malfunction of the endoscope. Reuse of the endoscope may cause cross-contamination potentially leading to infections.
2. Confirm that the opening of the insufflation/rinsing valve is not blocked or covered, and that the insufflation pressure does not exceed the given limit. If gas is excessively insufflated into the patient this may result in patient pain, bleeding, perforation and/or gas embolism.
3. Prior to use always perform an inspection and functionality check according to sections 3.1 and 3.4. Do not use the device if the endoscope or its packaging is damaged in any way or if the functionality check fails, as this can lead to patient injury or infection.

4. Patient leakage currents may be additive, when using energised endotherapy accessories. Do not use energised endotherapy accessories which are not classified as "type CF" or "type BF" applied parts according to IEC 60601-1, as that could lead to too high patient leakage current.
5. Do not perform procedures with High Frequency (HF) endotherapy accessories if flammable or explosive gases are present in the gastrointestinal tract as this may result in serious injury to the patient.
6. Always observe the live endoscopic image when inserting, withdrawing, or operating the endoscope. Failure to do so may result in patient injury, bleeding and/or perforation.
7. Ensure that the insufflator is not connected to the auxiliary water inlet as this may cause over insufflation which can result in patient pain, bleeding, perforation and/or gas embolism.
8. The distal tip of the endoscope may get warm due to heating from the LEDs. Avoid long periods of contact between the distal tip of the endoscope and the mucosa as sustained contact may cause tissue damage.
9. Do not insert or withdraw the endoscope if an endotherapy accessory is protruding from the distal end of the working channel as this may result in injury to the patient.
10. If the biopsy valve is left uncapped and/or if the biopsy valve is damaged it can reduce the efficacy of the endoscope's suction functionality, and may leak or spray patient debris or fluids, posing a risk of infection. When the valve is uncapped, place a piece of sterile gauze over it to prevent leakage.
11. Always use gauze to pull the endotherapy accessory through the biopsy valve as patient debris or fluids may leak or spray, posing a risk of infection.
12. During the procedure always wear personal protective equipment (PPE) to protect against contact with potentially infectious material. Failure to do so may cause contamination potentially leading to infections.
13. Using HF endotherapy accessories with endoscope may disturb the image on the displaying unit which may lead to patient injury. To reduce disturbance, try alternative settings on the HF generator with lower peak voltages.
14. Portable Radio Frequency (RF) communications equipment (including peripherals such as antenna cables and external antennas) should be used no closer than 30 cm (12") to any part of the endoscope and the displaying unit, including cables specified by the manufacturer. Otherwise, degradation of the performance of this equipment could result which could lead to patient injury.

CAUTIONS

1. Only use the endoscope with medical electrical equipment that complies with IEC 60601, and any applicable collateral and/or particular standards. Failure to do so may lead to equipment damage.
2. Prior to using any HF endotherapy accessory, check the compatibility with the endoscope. Always follow the IFU of the third-party device. Failure to do so may lead to equipment damage.
3. Do not activate energised endotherapy accessories before the distal end of the endotherapy accessory is in the field of view and is extended at an appropriate distance from the distal tip of the endoscope as this may result in endoscope damage.
4. Do not apply oil-based lubrication in the working channel as this may increase friction when inserting endotherapy accessories.
5. Do not coil the insertion tube or umbilical cord to a diameter of less than 20 cm (8") as this may damage the endoscope.
6. Do not drop, bump, bend, twist or pull any portion of the endoscope with excessive force as the endoscope may get damaged leading to failure in functionality.
7. Do not use excessive force to advance an endotherapy accessory through the working channel. Doing so may cause damage to the working channel of the endoscope.

1.6. Potential adverse events

Possible complications include (not exhaustive):

- Gas embolism
- Gagging
- Gastric-to-pulmonary aspiration
- Mucosal laceration
- Mucosal bleeding
- Perforation
- Peritonitis

1.7. General notes

If, during the use of this device or as a result of its use, a serious incident occurs, please report it to the manufacturer and to your national authority.

2. Device description

The endoscope is to be connected to an Ambu displaying unit. For information about Ambu displaying units, please refer to the Ambu displaying unit's Instructions for Use.

2.1. Device Parts

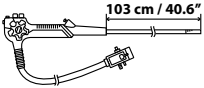
Pictogram	Finished Good Name	Finished Good Number	Distal end outer diameter	Working Channel inner diameter
	Ambu® aScope™ Gastro	483001000	9.9 mm 0.39" 29.7 Fr	2.8 mm 0.11" 8.4 Fr
	Ambu® aScope™ Gastro Large	582001000	11.5 mm 0.45" 34.5 Fr	4.2 mm 0.17" 12.6 Fr

Description of components and functions

The endoscope is a sterile and single-use gastroscope for use within the upper GI tract. It is intended for left-handed use. The endoscope is inserted into the patient's upper GI tract through the mouth and is powered by connection to the displaying unit. The endoscope can be used with endotherapy accessories and ancillary equipment for endoscopic procedures. The components of the endoscope are denoted in Figure 1 and are described within the associated table underneath it. The working channel allows for the passage of endotherapy accessories, instillation of fluids, and suction of fluids. The auxiliary water system allows the instillation of fluids. The insufflation/rinsing fluid management system allows the instillation of CO₂ to expand the GI lumen and rinsing of the lens. The optical module in the distal tip consists of a camera housing which contains a camera and LED light sources. The user can angulate the distal tip in multiple planes for visualization of the upper GI tract by turning the control wheels to activate the bending section. The bending section can bend up to 210° enabling a retroflexion to visualize the fundus and esophageal sphincter.

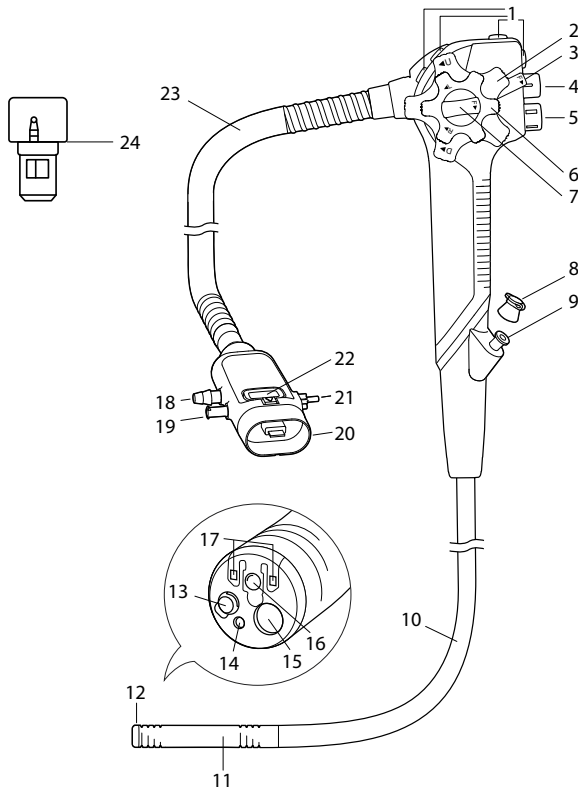
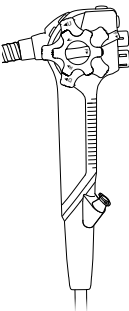

Figure 1: Schematic representation of the endoscope with references to relevant components.

No.	Part	Function
	Control section	The user holds the endoscope at the control section with the left hand. The control wheels and remote switches/programmable buttons may be manipulated with the left and/or right hand.

No. on Fig.1	Part	Function
1	Remote switches/ programmable buttons	The user activates functions on the displaying unit. The functions of the remote switches/programmable buttons are pre-configured from factory and can be re-configured according to the user's preference. Each button can be programmed to be sensitive on both short and long press. See displaying unit IFU for further details.
2	Up/down control wheel	The Up/Down control wheel manipulates the bending section of the endoscope. When this wheel is turned in the "U" direction, the bending section moves UP; when the wheel is turned in the "D" direction, the bending section moves DOWN.
3	Up/down angulation lock	Turning this lock in the "F" direction frees angulation. Turning the lock into the opposite direction locks the bending section at any desired position along the up/down axis.
4	Suction valve	The removable suction valve controls suction. When pressed fully down, suction is activated to remove any fluids, debris or gas from the patient.
5	Insufflation/ rinsing valve	The insufflation/rinsing valve controls insufflation and lens rinsing. Placing a finger on the opening of the valve activates insufflation. When pressed fully down, lens rinsing is activated.
6	Right/left control wheel	The Right/Left control wheel manipulates the bending section of the endoscope. When this wheel is turned in the "R" direction, the bending section moves RIGHT; when the wheel is turned in the "L" direction, the bending section moves LEFT.
7	Right/left angulation lock	Turning this lock in the "F" direction frees angulation. Turning the lock into the opposite direction locks the bending section at any desired position along the right/left axis.
8	Biopsy valve	The biopsy valve seals the working channel.
9	Working channel port	The working channel functions as: <ul style="list-style-type: none"> • Suction channel. • Channel for the insertion or connection of endotherapy accessories. • Fluid feed channel (from a syringe via the biopsy valve).
10	Insertion tube	The flexible insertion tube is inserted into the patient's upper GI tract.
11	Bending section	The bending section is the maneuverable part of the endoscope, that can be controlled by the control wheels and angulation locks.
12	Distal tip	The distal tip holds the camera, the light source (two LEDs), the working channel outlet, the insufflation/rinsing nozzle, and the auxiliary water jet outlet.
13	Insufflation/ rinsing nozzle	Nozzle for lens rinsing and insufflation.

14	Auxiliary water jet outlet	The auxiliary water jet system is used for endoscopic irrigation of the patient's upper GI tract.
15	Working channel outlet	This is the opening of the working channel at the distal end.
16	Camera	Enables visualization of the upper GI tract.
17	Light source (LED)	Enables illumination of the upper GI tract.
18	Suction connector	Connects the endoscope to the suction tube.
19	Auxiliary water jet connector	Connects the endoscope to the irrigation tube of the irrigation pump. The auxiliary water jet connector has an integrated one-way valve to reduce the risk of backflow.
20	Endoscope connector	Connects the endoscope to the grey connector port of the displaying unit. Ancillary equipment for suction, insufflation, lens rinsing and irrigation can be attached to the endoscope connector.
21	Insufflation/rinsing connector	Connects the endoscope to the sterile water bottle to enable insufflation and lens rinsing.
22	Release button	Press the button when disconnecting the endoscope from the displaying unit.
23	Umbilical cord	Connects the control section with the endoscope connector.
24	Spare suction valve	Can be used to replace the existing suction valve in case of blockage or damage.

2.2. Device compatibility

The endoscope can be used in conjunction with:

- Ambu® aBox™ 2.
- Insufflators for endoscopic gastrointestinal procedures with a constant flow of medical grade gas with a maximum supply pressure of 80 kPa (12 psi).
- Standard insufflation/rinsing fluid management tubing sets compatible with Olympus endoscopes including sterile water bottle.
- Vacuum source to provide aspiration with a maximum vacuum of -76 kPa (-11 psi.)
- Standard flexible suction tubes.
- Irrespective of the chosen fluid management system, the suction container assembly used must feature overflow protection in order to prevent fluids from entering the system; this feature is commonly referred to as "self-sealing", "shut-off-filter" or similar.
- Gastrointestinal endotherapy accessories specified to be compatible with a working channel with an inner diameter (ID) of 2.8 mm/8.4 Fr or less for aScope Gastro and with an ID of 4.2 mm/12.6 Fr or less for aScope Gastro Large.
- Gastrointestinal endotherapy accessories specified to be compatible with a distal end with an outer diameter (OD) of 9.9 mm/29.7 Fr for aScope Gastro and with an OD of 11.5 mm/34.5 Fr for aScope Gastro Large.
- There is no guarantee that endotherapy accessories selected using only this minimum working channel size and/or outer diameter of distal end will be compatible with the endoscope.
- Medical-grade water-based lubricants, iodine-based contrast agents, lipiodol, hemostatic agents, lifting agents, antifoaming agents, tattoo for permanent staining, and dyes for vital staining.
- Sterile water.
- HF electrosurgical equipment fulfilling IEC 60601-2-2. The application of high-frequency current may interfere with the endoscopic image. This does not indicate a malfunction.
- Auxiliary irrigation pump for endoscopic gastrointestinal procedures with a Luer connector.

3. Use of the device

The numbers in grey circles refer to the quick guide on page 2. Before each procedure, prepare and inspect each new endoscope as instructed below. Inspect other equipment to be used with the endoscope as instructed in their respective instruction manuals. Should any irregularity be observed after inspection, follow the instructions as described in section 6 "Troubleshooting". If the endoscope malfunctions, do not use it. Contact your Ambu sales representative for further assistance.

3.1. Inspection of the device 1

- Check that the pouch seal is intact, and that the endoscope's expiration date has not yet passed. In case the pouch seal has been damaged or the expiration date is passed, the endoscope must be discarded. 1a
- Carefully peel off the peel pouch packaging of the endoscope and remove the protective elements from the control section and the distal end. 1b
- Carefully run your hand back and forth over the entire length of the insertion tube, including the bending section and distal tip, of the endoscope to make sure that there are no impurities or damages on the product such as rough surfaces, sharp edges or protrusions which may harm the patient. Make sure to use an aseptic technique when performing the above. Otherwise, the sterility of the product will be compromised. 1c
- Inspect the distal end of the endoscope's insertion tube for scratches, cracks or other irregularities.
- Confirm that the top opening of the insufflation/rinsing valve is not blocked.
- Turn the Up/Down and Right/Left control wheels in each direction until their respective stops and then return them to their neutral position. Confirm that the bending section functions smoothly and correctly, that the maximum angulation is achieved and that the bending section returns to the neutral position. 1d
- Confirm that the angulation locks are functional by locking and releasing them as described in section 2.1. Turn the control wheels fully in all directions, lock the angulation in a fully angulated position and confirm that the bending section is stable. Release the angulation locks and confirm that the bending section straightens out.
- Using a syringe, flush sterile water into the working channel. Ensure that there are no leakages and that the water is emitted from the distal tip. 1e
- If necessary, confirm compatibility with applicable accessory devices.
- A spare suction valve is available if needed to replace the preinstalled one in the endoscope. The spare suction valve is included in the packaging.
- A new endoscope should be readily available so the procedure can be continued in case a malfunction occurs.

3.2. Preparations for use

Prepare and inspect displaying unit, CO₂ insufflator, sterile insufflation/rinsing water bottle, auxiliary irrigation pump, sterile water bottle, vacuum source and suction container including tubes as described in their respective instruction manuals.

- Power up the displaying unit. 2
- Carefully align the arrows on the endoscope connector with the grey port of the displaying unit to prevent damage to the connectors. 3
- Connect the endoscope to the displaying unit by plugging the endoscope connector into its corresponding grey port on the displaying unit.
- Check that the endoscope is firmly locked to the displaying unit.
- When using the endoscope, it is recommended to use a mouthpiece to prevent the patient from accidentally biting the insertion tube.

3.3. Attaching ancillary equipment

The endoscope is designed to work with most commonly available medical suction and insufflation/rinsing fluid management systems. The endoscope does not produce negative pressure itself and therefore an external vacuum source (e.g. wall suction or medical grade suction pump) will be required to operate the system. As the endoscope has a standard suction connector, standard suction tubes are compatible with the endoscope as long as a firm and tight connection is established. It is the responsibility of the user to consult and follow all third-party manufacturer instructions and guidance applicable to the endoscopic fluid management system chosen for use with the endoscope. To perform patient examinations

or procedures, all fluid containers (sterile water bottles and suction containers) must be properly and securely arranged in order to prevent spillage whereby maintaining a safe working environment. Place the containers in the designated locations and connect them according to the instructions in this section. When using third-party devices with the endoscope, always consult and follow the instructions for use accompanying the third-party device.

Connection to the insufflation/rinsing fluid management system 4

- If ancillary equipment is ON turn OFF.
- Connect the endoscope using a new disposable or sterilized reusable insufflation/rinsing fluid management tubing set.
- Please note that a new disposable or sterilized reusable water bottle must be used for each new procedure.
- Confirm that the connector fits properly and that it cannot be rotated.
- Turn the ancillary equipment back ON.

Connection to the auxiliary water jet system 5

- The endoscope has an auxiliary water jet connector with an integrated one-way valve to reduce the risk of backflow.
- If ancillary equipment is ON turn OFF.
- Connect the irrigation tube to the auxiliary water jet connector located on the endoscope connector. A new disposable or sterilized reusable irrigation tube and water bottle is required for each new procedure.
- Confirm that the connector fits properly.
- Turn the ancillary equipment back ON.

Connection to the suction system 5

Regardless of the vacuum source chosen, the endoscope will require the source to provide a vacuum for the endoscope to operate normally. Failure to provide the minimum vacuum requirements could result in a decreased suction capacity. Irrespective of the chosen medical suction system, overflow protection must be a feature of the suction container setup utilized to prevent fluids from entering the endoscopic system. This feature is commonly referred to as "self-sealing" feature or a "shut-off-filter", or similar mechanisms. Please note that a new disposable or sterilized reusable suction tube and new disposable or sterilized reusable suction container is required for each new procedure.

- If ancillary equipment is ON turn OFF.
- When all other connections are made, fit the end of the suction tube securely over the suction connector located on the endoscope connector.
- Connect the other end of the suction tube to the suction container and establish a connection to the external vacuum source (wall suction or medical suction pump) from here. Always read and follow the IFU of ancillary equipment.
- Turn the ancillary equipment back ON.

3.4. Inspection of the endoscopic system

Checking the working channel 6

- Confirm that the biopsy valve is attached to the working channel port. Gastrointestinal endotherapy accessories labelled for use with a working channel with an inner diameter (ID) of 2.8 mm/8.4 Fr or less for aScope Gastro and with an inner diameter (ID) of 4.2 mm/12.6 Fr or less for aScope Gastro Large are compatible. There is no guarantee that endotherapy accessories selected using only this minimum working channel size will be compatible with the endoscope.
- Compatibility of selected endotherapy accessories should be tested prior to procedure.

Inspection of the Image 7

- Verify that a live video image and correct orientation appears on the monitor by pointing the distal end of the endoscope towards an object, e.g. the palm of your hand.
- Adjust the image preferences on the displaying unit if necessary. See displaying unit's IFU for further details.
- If the image is impaired and/or unclear, wipe the lens at the distal tip using a sterile cloth.
- The images must not be used as an independent source for diagnosis of any pathology. Physicians must interpret and qualify any findings by other means and in the light of the patient's clinical characteristics.

Checking the remote switches/programmable buttons

- All remote switches/programmable buttons should be checked to work normally even if they are not expected to be used.
- Press every remote switch/programmable button and confirm that the specified function works as expected.
- Each remote switch/programmable button can be programmed to be sensitive on both short and long press. See displaying unit's IFU for further details.

Checking the suction, rinsing and insufflation functionality

- Check that the suction and insufflation/rinsing valves work as expected by pressing the suction and insufflation/rinsing valves.
- Cover the opening of the insufflation/rinsing valve and confirm that the insufflation function works properly.
- Fully depress the insufflation/rinsing valve and confirm that the rinsing function works properly.

Checking the auxiliary water jet functionality

- Check the auxiliary water jet system by activating the auxiliary irrigation pump and confirm that irrigation function works properly.

3.5. Operating the device

Insertion of the endoscope 8

- Insert a suitable mouthpiece and place it between the patient's teeth or gums.
- If necessary, apply a medical-grade lubricant as denoted in sec. 2.2 to the distal section of the endoscope.
- Insert the distal end of the endoscope through the opening of the mouthpiece, then from the mouth to the pharynx while viewing the endoscopic image. Do not insert the endoscope beyond the proximal end maximum length mark.

Holding and maneuvering the endoscope

- The control section of the endoscope is designed to be held in the operator's left hand.
- The suction and insufflation/rinsing valves can be operated using the left index and middle fingers.
- The Up/down control wheel can be operated using the left thumb and supporting fingers.
- The operator's right hand is free to manipulate the distal end via the insertion tube of the endoscope.
- The right hand is intended to adjust the Right/left control wheel and the angulation locks.

Angulation of the distal end

- Operate the angulation control wheels as necessary to guide the distal end during insertion and observation.
- The endoscope angulation locks are used to hold the angulated distal end in position.

Insufflation/rinsing

- Cover the opening of the insufflation/rinsing valve to feed CO₂ from the insufflation/rinsing nozzle at the distal tip.
- Fully depress the insufflation/rinsing valve to feed sterile water onto the objective lens.

Instillation of fluids

- Fluids can be injected through the working channel by inserting a syringe into the working channel port of the endoscope. Insert the syringe completely into the port and press the plunger to inject fluid.
- Make sure you do not apply suction during this process, as this will redirect the injected fluids into the suction system.

Auxiliary water jet system

- Activate the auxiliary water jet system to apply irrigation.
- A delay in irrigation may be experienced if the auxiliary water jet system has not been pre-filled during the pre-procedural preparation.

Suction

- Press the suction valve to aspirate excess fluids or other debris obscuring the endoscopic image.
- For optimal suction capability, it is recommended to remove endotherapy accessories entirely during suction.
- Should the suction valve on the endoscope clog, remove and clean it or replace it with the spare suction valve attached on the mounting card.

Use of endotherapy accessories

- Always make sure to select the correct size of gastrointestinal endotherapy accessories for use in combination with the endoscope by consulting respective IFUs.
- Accessories should be compatible if they are designed for working channels with an inner diameter (ID) of 2.8 mm/8.4 Fr or less for aScope Gastro and with an ID of 4.2 mm/12.6 Fr or less for aScope Gastro Large, and/or for a distal tip with an outer diameter (OD) of 9.9 mm for aScope Gastro and an OD of 11.5 mm for aScope Gastro Large. However, there is no guarantee that accessories selected using only this minimum working channel size and/or outer diameter of distal end will be compatible with the endoscope. Thus, compatibility of selected accessories should be assessed prior to the procedure.
- Inspect the endotherapy accessory before use. Replace it if there is any irregularity in its operation or external appearance.
- If applicable, confirm that the tip of the endotherapy accessory is closed or retracted into its sheath. Insert the endotherapy accessory through the biopsy valve into the working channel. Hold the accessory approximately 4 cm (1.5") from the biopsy valve and advance it slowly and straight towards the biopsy valve using short strokes while observing the endoscopic image. Open the biopsy valve cap to ease insertion for large-diameter endotherapy accessories.
- Advance the accessory carefully through the working channel until it exits the working channel outlet and can be seen on the monitor.
- If applicable, ensure that the accessory is in a neutral position before withdrawing it from the endoscope through the biopsy valve.
- If the accessory cannot be removed, retract the endoscope as described in the next paragraph while observing the endoscopic image.

Withdrawal of the endoscope 9

- Stop using the image magnification (zoom) function of the displaying unit.
- Aspirate accumulated air, blood, mucus or other debris by activating the suction valve.
- Move the up/down angulation lock to the "F" direction to release the angulation.
- Turn the right/left angulation lock to the "F" direction to release the angulation.
- Carefully withdraw the endoscope, while observing the endoscopic image.
- Remove mouthpiece from the patient's mouth.

3.6. After use

- Detach all tubes and tubing sets from the endoscope connector. 10
- Press the release button and disconnect the endoscope from the displaying unit. 11
- Check the endoscope for any missing parts, evidence of damage, cuts, holes, sagging, or other irregularities on the bending and insertion section including the distal tip. 12
- Should any irregularities exist, immediately determine if any parts are missing and take the necessary corrective action(s).

Disposal of the endoscope 13

- The used endoscope is considered contaminated after use and must be disposed of including all packaging and the spare suction valve in accordance with local guidelines for collection of infected medical devices with electronic components.

Returning devices to Ambu

- Should it be necessary to return an endoscope to Ambu for evaluation, please contact your representative at Ambu for instructions and/or guidance.
- To prevent infection, it is strictly forbidden to ship contaminated medical devices.
- As a medical device, endoscope must be decontaminated on site prior to shipment to Ambu.
- Ambu reserves the right to return contaminated medical devices to the sender.

4. Device specifications

4.1. Standards applied

The endoscope conforms with:

- IEC 60601-1 Medical electrical equipment – Part 1: General requirements for basic safety and essential performance.
- IEC 60601-1-2 Medical electrical equipment – Part 1-2: General requirements for basic safety and essential performance – Collateral standard: Electromagnetic disturbances – Requirements and tests.
- IEC 60601-2-18 Medical electrical equipment – Part 2-18: Particular requirements for the basic safety and essential performance of endoscopic equipment.
- ISO 10993-1 Biological evaluation of medical devices – Part 1: Evaluation and testing within a risk management process.
- ISO 8600-1 Endoscopes – Medical endoscopes and endotherapy devices – Part 1: General requirements.

4.2. Technical device specifications

No.	Product specification		
1	Insertion section dimensions	aScope Gastro	aScope Gastro Large
1.1	Bending angle		
	Up:	210°	210°
	Down:	90°	120°
	Left:	100°	100°
	Right:	100°	100°
1.2	Max. insertion portion outer diameter	10.4 mm / 0.41" / 31.2 Fr	12 mm / 0.47" / 36.0 Fr
1.3	Distal tip diameter	9.9 mm / 0.39" / 29.7 Fr	11.5 mm / 0.45" / 34.5 Fr
1.4	Working length	103 cm / 40.6"	
2	Working channel	aScope Gastro	aScope Gastro Large
2.1	Min. working channel width	2.8 mm / 0.11" / 8.4 Fr	4.2 mm / 0.17" / 12.6 Fr
3	Optics		
3.1	Field of view	140°	
3.2	Direction of view	0° (forward pointing)	
3.3	Depth of field	3 – 100 mm / 0.12 – 3.94"	
3.4	Illumination method	LED	
4	Connections		
4.1	The insufflation/rinsing connector connects to a medical grade CO ₂ insufflator	Max. 80 kPa / 12 psi (relative pressure)	
4.2	The suction connector connects to a vacuum source	Max. -76 kPa / -11 psi (relative pressure)	
4.3	The auxiliary water inlet connects to an auxiliary irrigation pump	Max. 500 kPa / 72.5 psi (relative pressure)	

5 Operating environment		
5.1	Temperature	10 – 40 °C / 50 – 104 °F
5.2	Relative humidity	30 – 85 %
5.3	Atmospheric pressure	80 – 106 kPa / 12 – 15 psi
6 Sterilization		
6.1	Method of sterilization	Ethylene oxide (EtO)
7 Biocompatibility		
7.1	Endoscope is biocompatible	
8 Storage and transportation conditions		
8.1	Transportation temperature	-10 – 55 °C / 14 – 131 °F
8.2	Storage temperature	10 – 25 °C / 50 – 77 °F
8.3	Relative humidity	10 – 95 %
8.4	Atmospheric pressure	50 – 106 kPa / 7.3 – 15 psi

5. Troubleshooting

The following tables show the possible causes of and countermeasures against challenges that may occur due to equipment setting errors or damage to the endoscope. Make sure to contact your local Ambu representative for detailed information if indicated.

Prior to use please do the pre-check as described in section 3.

5.1. Angulation and angulation locks

Possible problem	Possible cause	Recommended action
Increased resistance during control wheel operation.	The angulation lock is activated.	Release the angulation lock.
One or more of the control wheels do not turn.	Control wheel angulation locks are activated.	Release the angulation lock.
Angulation lock is not working.	Angulation lock is not correctly activated.	Activate the locking function by turning the angulation lock to the end stop.
Bending section does not angulate when control wheel is operated.	Endoscope is defective.	Withdraw the endoscope and connect a new endoscope.
Max. bending angles cannot be reached.	Endoscope is defective.	Withdraw the endoscope and connect a new endoscope.
Bending section angulates in the opposite direction.	Endoscope is defective.	Withdraw the endoscope and connect a new endoscope.

5.2. Rinsing and insufflation

Possible problem	Possible cause	Recommended action
Rinsing impaired or not possible.	Insufflation/rinsing fluid management tubing set not properly connected.	Connect the rinsing tubing properly to the endoscope.

Possible problem	Possible cause	Recommended action
Insufflation not possible or insufficient.	The water bottle is empty.	Replace the water bottle with a new one.
	CO ₂ regulator is not working or not switched on.	Refer to the CO ₂ regulator IFU.
	Sterile water source setup suboptimal.	Confirm that water source is installed according to its IFU.
	Insufflation/rinsing valve not fully activated.	Fully depress the insufflation/rinsing valve.
	Endoscope is defective.	Withdraw the endoscope and connect a new endoscope.
	CO ₂ regulator is not connected, switched on or otherwise not working correctly.	Connect or switch on compatible regulator. Adjust regulator settings. Refer to the CO ₂ regulator IFU.
	Insufflation/rinsing fluid management tubing set not properly connected.	Connect the insufflation/rinsing fluid management tubing set to the endoscope.
	Sterile water source set-up sub-optimally.	Refer to the water source IFU.
	CO ₂ – source is empty or remaining pressure too weak.	Connect a new CO ₂ – source.
	Suction is activated.	Deactivate suction.
	Endoscope is defective.	Withdraw the endoscope and connect a new endoscope.
Continuous insufflation without operating insufflation/rinsing valve.	Insufflation/rinsing valve opening is blocked.	Withdraw the endoscope and connect a new endoscope.

5.3. Suction

Possible problem	Possible cause	Recommended action
Diminished or no suction.	Vacuum source/suction pump is not connected or not switched ON.	Connect the vacuum source/suction pump and power ON.
	Suction container is full or not connected.	Change the suction container if it is full. Connect a suction container.
	Suction valve is blocked.	Remove the valve and rinse with sterile water using a syringe and reuse the valve. Or replace the part with the spare suction valve.
	Biopsy valve is not properly connected.	Attach valve correctly.
	Biopsy valve cap is open.	Close cap.
	Vacuum source/suction pump too weak.	Increase vacuum pressure.

Possible problem	Possible cause	Recommended action
Diminished or no suction.	Vacuum source/suction pump is defective.	Replace with a new vacuum source/suction pump.
	Working channel is blocked.	Flush sterile water with a syringe through the working channel.
	Endoscope is defective.	Withdraw the endoscope and connect a new endoscope.
Continuous suction	Suction valve remains depressed.	Gently pull the suction valve up to the off position.

5.4. Working channel and use of accessories

Possible problem	Possible cause	Recommended action
Working channel access is constricted or blocked (endotherapy accessories do not pass through channel smoothly).	Endotherapy accessory is not compatible.	Select a compatible endotherapy accessory.
	Endotherapy accessory is open.	Close the endotherapy accessory or retract it into its sheath.
	Working channel is blocked.	Try to unblock it by flushing sterile water into the working channel with a syringe.
	Biopsy valve is not open.	Open the cap of the biopsy valve.
High flexion of bending section.	Straighten the bending section as much as possible without losing the POSITION of the endoscopic image.	Straighten the bending section as much as possible without losing the endoscopic image.

5.5. Image quality and brightness





Possible problem	Possible cause	Recommended action
No video image.	Displaying unit or ancillary equipment is not switched ON.	Switch displaying unit and ancillary equipment ON.
	Endoscope connector is not properly connected to the displaying unit.	Connect the endoscope connector properly to the displaying unit.
	Endoscope is defective.	Withdraw the endoscope and connect a new endoscope.
	Displaying unit is defective.	Contact your Ambu representative.
Image suddenly darkens.	Camera or illumination failure.	Switch ON LEDs as described in displaying unit IFU.
		Withdraw the endoscope and connect a new endoscope.
Blurry image	Objective lens is dirty.	Rinse the objective lens.
	Water drops on the outside of the lens.	Insufflate and/or rinse to remove water drops from the lens.
	Condensation on the inside of the lens.	Increase the water temperature in the water bottle and continue to use the endoscope.
	Displaying unit image settings incorrect.	See displaying unit's IFU.

Possible problem	Possible cause	Recommended action
Flickering images.	Signal interference from activated HF endotherapy accessory.	Use alternative mode or settings on the HF-generator with lower peak voltage (pV).
Dark or over-illuminated image.	Displaying unit image settings incorrect.	See displaying unit's IFU.
	Endoscope is defective.	Withdraw the endoscope and connect a new endoscope.
The colour tone of the endoscopic image is unusual.	Displaying unit image settings improper.	See displaying unit IFU.
	Endoscope is defective.	Withdraw the endoscope and connect a new endoscope.
Picture is frozen.	Endoscope is defective.	Withdraw the endoscope and connect a new endoscope.
Unusual image contrast levels.	Displaying unit is defective.	Contact your Ambu representative.
	Advanced Red Contrast (ARC) mode unintentionally ON/OFF.	See displaying unit IFU.
	Improper image/ARC settings.	See displaying unit IFU.

5.6. Remote switches/programmable buttons

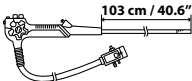
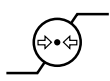
Possible problem	Possible cause	Recommended action
The remote switches are not working or not working properly.	Endoscope connector is not properly connected to the displaying unit.	Connect the endoscope connector properly to the displaying unit.
	Remote switch configuration changed.	Return to standard configuration of the remote switches or change the settings.
	Wrong remote switch operated.	Operate the correct remote switch.
	Endoscope is defective.	Withdraw the endoscope and connect a new endoscope.
	Displaying unit is defective.	Contact your Ambu representative.

6. Explanation of symbols used

Symbol	Description	Symbol	Description
	Working length of the insertion tube		Atmospheric pressure limitation
 Max OD	Maximum insertion portion width (Maximum outer diameter)		Humidity limitation
 Min ID	Minimum working channel width (Minimum inner diameter)		Temperature limitation

Symbol	Description	Symbol	Description
	Country of manufacturer: Made in Malaysia		Medical Device
	Field of view		Packaging level ensuring sterility
	Warning		Global Trade Item Number
	Do not use if package is damaged		UL Recognized Component Mark for Canada and the United States
	IFU symbol	pMax H₂O	Maximum relative supply pressure by auxiliary irrigation pump. Values are depicted in kPa/psi
pMax CO₂	Maximum relative supply pressure by CO ₂ insufflator. Values are depicted in kPa/psi		UK Conformity Assessed
pMax VAC	Maximum relative negative pressure supplied by vacuum source. Values are depicted in kPa/psi		Importer (For products imported into Great Britain only)
	UK Responsible Person		Date of manufacture
	Manufacturer		Use by date
	Catalogue number		Batch code
	Consult instruction for use		Indicates that a product is compliant with European legislation for medical devices and that it has been verified by a notified body
	Do not re-use		

A full list of symbol explanations can be found on ambu.com/symbol-explanation.

Ambu

Ambu A/S



Baltorpbakken 13
2750 Ballerup
Denmark



2797

T +45 72 25 20 00
ambu.com



UK
CA

0086

Ambu Ltd

First Floor, Incubator 2

Alconbury Weald Enterprise Campus

Alconbury Weald

Huntingdon PE28 4XA

United Kingdom

ambu.co.uk

Ambu® and other trademarks are trademarks of Ambu A/S.